



On The Cutting Edge of Technological Evolution

6233 E. Sawgrass Rd • Sarasota, FL. 34240 • (941)377-5775 FAX(941)378-4226
www.acscontrol.com



22-Feb-08

ACS-LCD-128x64

LCD Graphic Display Terminal

General Description

The LCD Graphic Display Terminal is designed to provide a cost effective RS-232 operator interface. The display is controllable via a simple serial command protocol or with ANSI control sequences. Commands provide text printing with multiple fonts, graphic drawing, tone generation and save/restore of multiple screen images. Multiple displays can be addressed on the same serial line. Support is provided for debouncing and reporting for either a 7 key discrete or 12 key matrix style keypad. A programmable LED backlight illuminates during command and key processing.

Features

- Transflective LCD Display with LED backlight and noon to 6:00PM viewing angle
- Scan/Matrix & non-Matrix keypad inputs
- On board 250mW audio amplifier for tone generator
- 30 User programmable graphics pages expandable to 94
- User configurable non-volatile configuration settings
- Small form-factor, mounts in standard dual-gang electrical switchbox with optional mounting plate and membrane keypad overlay

Typical Applications

The module connects to the Host controller with a cable providing power and a RS-232 serial data connection. Typical uses include:

- Home automation
- Internet Appliances, Kiosks
- Industrial Computers

Specifications

Number of Dots: 128 x 64
 Module Dimension: 93.0(W) x 70.0(H) x 13.5Max(T)
 Viewing Area: 71.7(W) x 39.0(H)
 Active Area: 66.52(W) x 33.24(H)
 Dot Size: 0.48(W) x 0.48(H)
 Dot Pitch: 0.52(W) x 0.52(H)
 Viewing Angle: +40 degrees H & V
 Viewing Direction: 12 O'CLOCK Superwide

BackLight: LED(Yellow-Green)
 LCD Type: STN-YELLOW(Positive/Transflective)
 STN-BLUE(Negative/Transflective)
 Contrast Ratio: 5:1
 Operating Temperature: -20 to +70 degrees C
 Supply Voltage: 10 – 15VDC
 Current (LED Backlight Off): 32mA
 Current(LED Backlight On): 190mA



Display Wiring

Serial and Power Connector

COMM

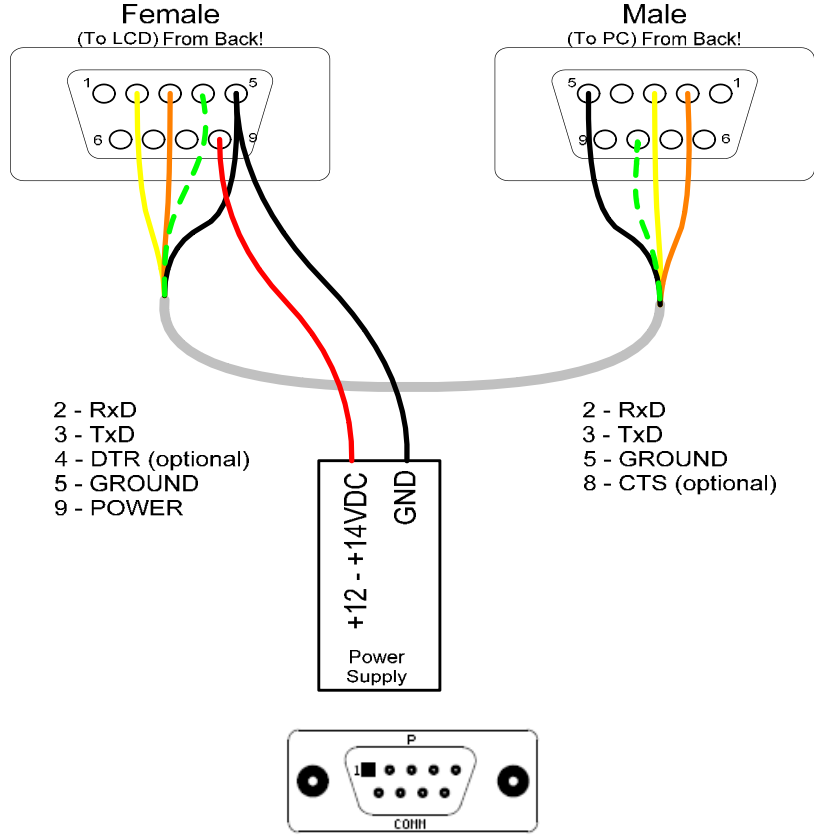

COMM Pin #	PC DB9 Pin #	PC DB25 Pin #	Power Supply	SIGNAL
2	3	2	N/C	RXD
3	2	3	N/C	TXD
4 (optional)	8 (optional)	5 (optional)	N/C	CTS
5	5	7	GND	GND
9	N/C	N/C	+12-14VDC	+12-14VDC

Mating Connector: DB-9 Female

Speaker / Reset Connector

SPKRESET

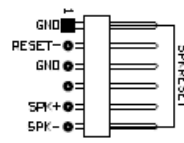

SPKRESET Pin #	SIGNAL
1	GND
2	RESET-
3	GND
4	N/U
5	Speaker +
6	Speaker -

Mating Connector: KK-100 0.1" 6 position

Keypad
Connector
MENUPAD

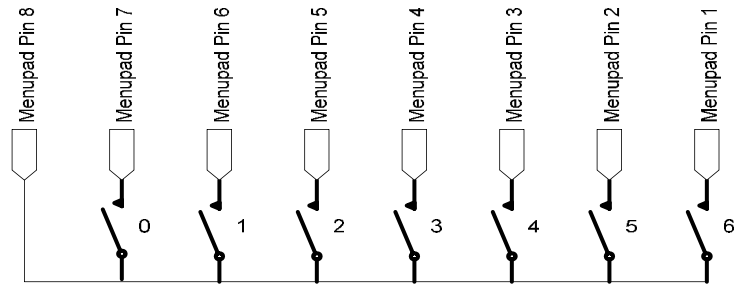

Debounce Wiring

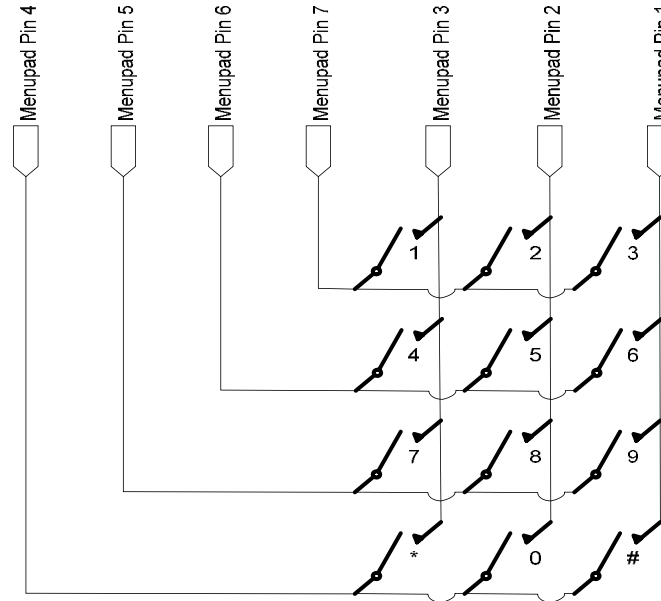

Scan/Matrix Wiring

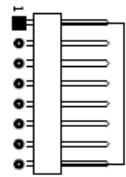

MENUPAD Pin #	Debounce	Scan/Matrix
1	Input #7	Column #3
2	Input #6	Column #2
3	Input #5	Column #1
4	Input #4	Row #4
5	Input #3	Row #3
6	Input #2	Row #2
7	Input #1	Row #1
8	GND	GND

Mating Connector KK-100 0.1" 8 position

Mechanical

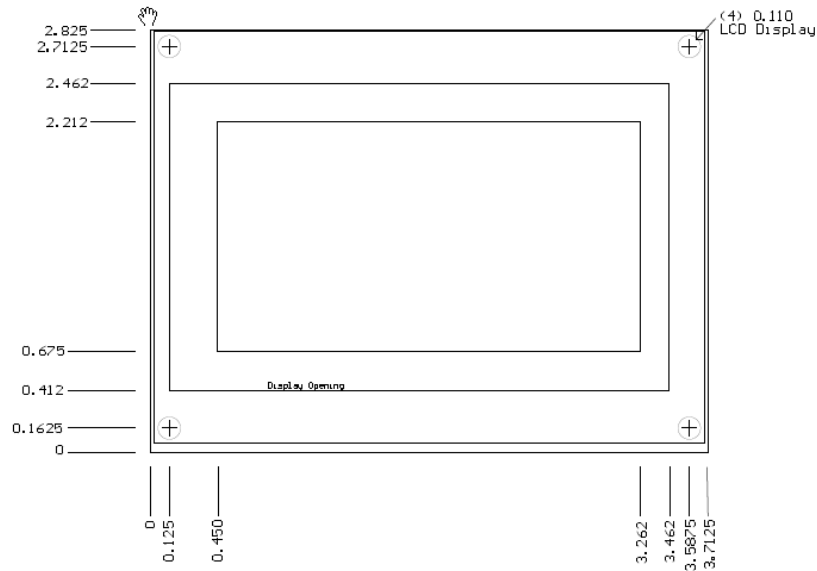

User Configuration Settings

Setting	Description
Baud Rate	1200, 2400, 4800, 9600 (default), 19200, 38400, 57600
Protocol SOH & ETX	0 = ANSI, 1=SOH/ETX(default)
ANSI Line Wrap	0 = no wrap (default), 1 = ANSI lines exceeding screen width wrap to next line
ANSI Add LF to CR	0 = CR (default), 1 = incoming CR replaced by CR/LF pair
Display Comm Addr	0 = no address (default), xx = display's address for SOH/ETX protocol, sent after SOH
Rcv Char Backlight	0 = disabled, 1 = backlight on for time when characters received
Switch Backlight	0 = disabled, 1 = backlight on for time when switch pressed
Backlight Timeout	= number of seconds backlight stays lit (default = 30)
Switch Scan/Matrix	0 = debounce 7 keys (default), 1 = scan 3 x 4 matrix
Switch Send Opens	0 = only switch closures sent (default), 1 = send switch opens too
Switch Base Zero	0 = switch closures start at ASCII '0' (default), 1 = switch closures start at binary 0
Switches Polled	0 = switches sent autonomously (default), 1 = switches send when polled.
Power Up Disp Logo	0 = no logo upon reset, 1 = display graphic page 0 (logo) upon reset (default)
Power Up Disp Setng	0 = no settings shown upon reset, 1 = display settings screen upon reset (default)
Auto Clear Disp Sec	= number of seconds before display clears (default = 0, off)
Auto Clear DispLogo	= number of seconds before logo clears (default = 0, off)
Soft Major Version	= major version # of firmware
Soft Minor Version	= minor version # of firmware
End of Config	= end of configuration items placeholder
NV Status Byte	= NV status byte (default = 227)

Optional Accessories

ACS-LCD-128x64-MBSW

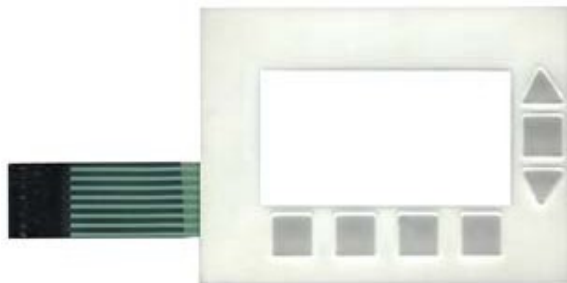

Membrane Switch Keypad

ACS-LCD-128x64-MP



Dual Gang Outlet Cover Mounting Plate

Protocol

(see User's Manual for more detailed information)

SOH / ETX Commands / Responses

Command	Serial Character Sequence
Print Command	<SOH> "P" {Row 0-255 (FF) in Two Digit ASCII Hex} {Starting Column 0-127(00-7F) in Two Digit ASCII Hex} {Font 0-5 in Single Digit ASCII Hex} {Type 1,2,4,8 in Single Digit ASCII Hex} {Justification 0, 1, 2, 3 in Single Digit ASCII Hex} {Up to 25 characters of text to be displayed} <ETX>
UnPrint Command	<SOH> "U" {Row 0-255 (FF) in Two Digit ASCII Hex} {Starting Column 0-127(00-7F) in Two Digit ASCII Hex} {Font 0-5 in Single Digit ASCII Hex} {Type 1,2,4,8 in Single Digit ASCII Hex} {Justification 0, 1, 2, 3 in Single Digit ASCII Hex} {Up to 25 characters of text to be un-displayed} <ETX>
Clear Command	<SOH> "C" {Row 0-255 (FF) in Two Digit ASCII Hex} {Starting Column 0-127(00-7F) in Two Digit ASCII Hex} {Ending Column 0-127(00-7F) in Two Digit ASCII Hex} <ETX>
Horizontal Load Command	<SOH> "H" {Row 0-255 (00-FF hex) in Two Digit ASCII Hex} {Column 0-127(00-7F hex) in Two Digit ASCII Hex} {Length of data 0-128(00-80 hex) in Two Digit ASCII Hex} {Data Bytes 0-255(00-FF hex) in Two Digit ASCII Hex} <ETX>
Graphic Command	<SOH> "G" {Row 0-255 (00-FF hex) in Two Digit ASCII Hex} {Column 0-127(00-7F) in Two Digit ASCII Hex} {Data 0-255(00-FF) in Two Digit ASCII Hex} <ETX>
Line Command	<SOH> "L" {Starting X 0-127(00-7F) in Two Digit ASCII Hex} {Starting Y 0-63(00-3F) in Two Digit ASCII Hex} {Ending X 0-127(00-7F) in Two Digit ASCII Hex} {Ending Y 0-63(00-3F) in Two Digit ASCII Hex} {Color 0-1(0-1) in Single Digit ASCII Hex} <ETX>
Box Command	<SOH> "B" {1 st Corner X 0-127(00-7F) in Two Digit ASCII Hex} {1 st Corner Y 0-63(00-3F) in Two Digit ASCII Hex} {2 nd Corner X 0-127(00-7F) in Two Digit ASCII Hex} {2 nd Corner Y 0-63(00-3F) in Two Digit ASCII Hex} {Color 0-1(0-1) in Single Digit ASCII Hex} <ETX>
Pixel Command	<SOH> "X" {X 0-127(00-7F) in Two Digit ASCII Hex} {Y 0-63(00-3F) in Two Digit ASCII Hex} {Color 0-1(0-1) in Single Digit ASCII Hex} <ETX>
Circle Command	<SOH> "I" {Center X 0-127(00-7F) in Two Digit ASCII Hex} {Center Y 0-63(00-3F) in Two Digit ASCII Hex} {Radius X 0-127(00-7F) in Two Digit ASCII Hex} {Color 0-1(0-1) in Single Digit ASCII Hex} <ETX>

Tone Command	<SOH> "T" {Frequency 26-4095Hz (01A-FFF) in Three Digit ASCII Hex} {Duration 0-255 Fiftieths (00-FF) in Two Digit ASCII Hex} <ETX>
Save Page Command	<SOH> "S" {Page number 0-255 (00-FF) in Two Digit ASCII Hex} <ETX>
Restore Page Command	<SOH> "R" {Page number 0-255 (00-FF) in Two Digit ASCII Hex} <ETX>
Backlight Command	<SOH> "b" {0=off, 1=on, 2=on timed in Single Digit ASCII Hex} <ETX>
Keypad Status Poll Command	<SOH> "K" <ETX>
Keypad Key Closure Response	<SOH> "K" {Two Digit ASCII Hex keycode} <ETX>
Keypad Key Opening Response	<SOH> "k" {Two Digit ASCII Hex keycode} <ETX>
Power-up / Reset Response	<SOH> "R" <ETX>

ANSI Subset Command / Responses

In ANSI mode the display provides 8 rows of 21 fixed pitch characters per row. The following ANSI commands are supported:

Command	Serial Character Sequence
BELL	Value (ASCII 7 decimal / 07 hex) Receipt of this character causes the display to produce a 1KHz tone for 0.2 seconds.
Backspace (BS)	Value (ASCII 8 decimal / 08 hex) Receipt of this character causes the display to move the cursor one position to the left.
Horizontal Tab (HT)	Value (ASCII 9 decimal / 09 hex) Receipt of this character causes the display to move the cursor right to the next tab stop. Moving past the rightmost tab stop causes the cursor to move to the beginning of the following line with display scrolling up if the cursor was on the last line. There are 4 tab stops per line at positions 4, 8, 12 and 16.
Line Feed (LF)	Value (ASCII 10 decimal / 0A hex) Receipt of this character causes the display to move the cursor down to the next line in the same column. The display will scroll up if the cursor was on the last line.
Vertical Tab (VT)	Value (ASCII 11 decimal / 0B hex) Receipt of this character causes the display to move the cursor down to the next line in the same column. The display will scroll up if the cursor was on the last line.
Form Feed (FF)	Value (ASCII 12 decimal / 0C hex) Receipt of this character causes the display to move the cursor down to the next line in the same column. The display will scroll up if the cursor was on the last line.
Carriage Return (CR)	Value (ASCII 13 decimal / 0D hex) Receipt of this character causes the display to move the cursor left to the first column on the current line. There is a User Configuration setting that will automatically add receipt of a Line Feed (LF) character after a carriage return if required.
Cancel (CAN)	Value (ASCII 24 decimal / 18 hex) Receipt of this character causes the display to abort any escape sequence that may be in process. No other action is taken.
Escape (ESC)	Value (ASCII 33 decimal / 1B hex) Receipt of this character causes the display to attempt to decode one or more of the following characters as a control or escape sequence that will affect the display.

(continued on next page)

Displayed Characters	Lower Bits	Upper Bits					
		0010	0011	0100	0101	0110	0111
	0000	space	0	@	P	`	p
	0001	!	1	A	Q	a	q
	0010	"	2	B	R	b	r
	0011	#	3	C	S	c	s
	0100	\$	4	D	T	d	t
	0101	%	5	E	U	e	u
	0110	&	6	F	V	f	v
	0111	\	7	G	W	g	w
	1000	(8	H	X	h	x
	1001)	9	I	Y	i	y
	1010	*	:	J	Z	j	z
	1011	+	;	K	[k	{
	1100	,	<	L	\	l	
	1101	-	=	M]	m	}
	1110	.	>	N	^	n	→
	1111	/	?	O	_	o	←
Reset Display (ESC c)	Values (ASCII 33, 99 decimal / 1B, 63 hex) Receipt of this character sequence causes the display to clear, the cursor position to move to the upper left corner and the backlight to turn off.						
Cursor Down (ESC D)	Values (ASCII 33, 68 decimal / 1B, 44 hex) Receipt of this character sequence causes the display to move the cursor down to the next line in the same column. The cursor will not move and the display will not scroll up if the cursor was on the last line.						
Cursor Down to column 1 (ESC E)	Values (ASCII 33, 69 decimal / 1B, 45 hex) Receipt of this character sequence causes the display to move the cursor down to the next line and the first column. The cursor will not move and the display will not scroll up if the cursor was on the last line.						
Cursor Up (ESC M)	Values (ASCII 33, 77 decimal / 1B, 4D hex) Receipt of this character sequence causes the display to move the cursor up to the previous line in the same column. The cursor will not move if the cursor was on the first line.						
ANSI Escape Sequences (ESC [)	Values (ASCII 33, 91 decimal / 1B, 5B hex) Receipt of this character sequence causes the display to attempt to decode one or more of the following characters as an ANSI control sequence. These sequences can have 1 or 2 parameters that are expressed as decimal numbers separated by a semicolon. The absence of a parameter in a control sequence causes it to assume a default value of zero.						
Cursor Up n lines (ESC [n A)	Values (ASCII 33, 91, 48-57, 65 decimal / 1B, 5B, 30-39, 41 hex) Receipt of this character sequence causes the display to move the cursor up 'n' lines in the same column. The cursor will not move up past the first line in the display.						
Cursor Up n lines to column 1 (ESC [n F)	Values (ASCII 33, 91, 48-57, 70 decimal / 1B, 5B, 30-39, 46 hex) Receipt of this character sequence causes the display to move the cursor up 'n' lines and to the first column. The cursor will not move up past the first line in the display.						
Cursor Down n lines (ESC [n B)	Values (ASCII 33, 91, 48-57, 66 decimal / 1B, 5B, 30-39, 42 hex) Receipt of this character sequence causes the display to move the cursor down 'n' lines in the same column. The cursor will not move past the bottom line in the display and the display will not scroll up.						
Cursor Down n lines to column 1 (ESC [n E)	Values (ASCII 33, 91, 48-57, 69 decimal / 1B, 5B, 30-39, 45 hex) Receipt of this character sequence causes the display to move the cursor down 'n' lines and to the first column. The cursor will not move past the bottom line in the display and the display will not scroll up.						
Cursor Right n characters (ESC [n C)	Values (ASCII 33, 91, 48-57, 67 decimal / 1B, 5B, 30-39, 43 hex) Receipt of this character sequence causes the display to move the cursor right 'n' characters on the same line. The cursor will not move past the end of the current line.						
Cursor Left n characters (ESC [n D)	Values (ASCII 33, 91, 48-57, 68 decimal / 1B, 5B, 30-39, 44 hex) Receipt of this character sequence causes the display to move the cursor left 'n' characters on the same line. The cursor will not move past the beginning of the current line.						
Move cursor to n (ESC [n G)	Values (ASCII 33, 91, 48-57, 71 decimal / 1B, 5B, 30-39, 47 hex) Receipt of this character sequence causes the display to move the cursor to column 'n' on the current line. The cursor will not move past the beginning or end of the current line.						
Move cursor to r, c (ESC [r ; c H)	Values (ASCII 33, 91, [[48-57], 59, [48-57]], 72 decimal / 1B, 5B, [[30-39], 3B, [30-39]], 48 hex) Receipt of this character sequence causes the display to move the cursor to row 'r', column 'c'. The value for 'r' ranges from 0 – 7, the value for 'c' ranges from 0 – 20.						
Erase all or part of display (ESC [n J)	Values (ASCII 33, 91, 48-50, 74 decimal / 1B, 5B, 30-32, 4A hex) Receipt of this character sequence causes part or all of the display to clear. If 'n' = 0, the display is cleared from the cursor position to the end. If 'n' = 1, the display is cleared from the beginning to the cursor position. If 'n' = 2 the entire display is cleared, and the cursor is moved to the upper left (0, 0).						

Erase all or part of line (ESC [n K)	Values (ASCII 33, 91, 48-50, 75 decimal / 1B, 5B, 30-32, 4B hex) Receipt of this character sequence causes part or all of the line that the cursor is on to clear. If 'n' = 0, the line is cleared from the beginning to the cursor position. If 'n' = 1, the line is cleared from the beginning to the cursor position. If 'n' = 2 the entire line is cleared. The position of the cursor is not affected by this command.																																
Save cursor position (ESC [n s)	Values (ASCII 33, 91, 114 decimal / 1B, 5B, 73 hex) Receipt of this character sequence causes the display to save the current cursor position.																																
Restore cursor position (ESC [n u)	Values (ASCII 33, 91, 116 decimal / 1B, 5B, 75 hex) Receipt of this character sequence causes the display to restore the previously saved cursor position.																																
Query Display Status (ESC [5 n)	Values (ASCII 33, 91, 53, 110 decimal / 1B, 5B, 35, 6E hex) Receipt of this character sequence causes the display to generate an <ESC> [0 n status message. If the display was configured for Switches Polled = 1, then this status message will be followed by any queued keypad response messages.																																
Query Cursor Position (ESC [6 n)	Values (ASCII 33, 91, 54, 110 decimal / 1B, 5B, 36, 6E hex) Receipt of this character sequence causes the display to generate an <ESC> [row ; column R status message. The value for row is 0 – 7, the value for column is 0 – 20.																																
Keypad Key Closure	<p>If the User Configuration setting for the keypad is set to Scan/Matrix, then the keypad response is as follows:</p> <pre> <SOH> "K" {Two Digit ASCII Hex keycode} <ETX> </pre> <p>If the User configuration setting for the keypad is set to Debounce, then the keypad response is as follows:</p> <table border="1"> <thead> <tr> <th>Input #</th> <th>ANSI</th> <th>Sequence</th> <th>Value(s)</th> </tr> </thead> <tbody> <tr> <td>1</td> <td>F1</td> <td>ESC [O P</td> <td>1B 5B 4F 50 00 00 00</td> </tr> <tr> <td>2</td> <td>F2</td> <td>ESC [O Q</td> <td>1B 5B 4F 51 00 00 00</td> </tr> <tr> <td>3</td> <td>F3</td> <td>ESC [O R</td> <td>1B 5B 4F 52 00 00 00</td> </tr> <tr> <td>4</td> <td>F4</td> <td>ESC [O S</td> <td>1B 5B 4F 53 00 00 00</td> </tr> <tr> <td>5</td> <td>UP ARROW</td> <td>ESC [B</td> <td>1B 5B 42 00 00 00</td> </tr> <tr> <td>6</td> <td>DOWN ARROW</td> <td>ESC [A</td> <td>1B 5B 41 00 00 00</td> </tr> <tr> <td>7</td> <td>ENTER</td> <td>CR</td> <td>0D</td> </tr> </tbody> </table>	Input #	ANSI	Sequence	Value(s)	1	F1	ESC [O P	1B 5B 4F 50 00 00 00	2	F2	ESC [O Q	1B 5B 4F 51 00 00 00	3	F3	ESC [O R	1B 5B 4F 52 00 00 00	4	F4	ESC [O S	1B 5B 4F 53 00 00 00	5	UP ARROW	ESC [B	1B 5B 42 00 00 00	6	DOWN ARROW	ESC [A	1B 5B 41 00 00 00	7	ENTER	CR	0D
Input #	ANSI	Sequence	Value(s)																														
1	F1	ESC [O P	1B 5B 4F 50 00 00 00																														
2	F2	ESC [O Q	1B 5B 4F 51 00 00 00																														
3	F3	ESC [O R	1B 5B 4F 52 00 00 00																														
4	F4	ESC [O S	1B 5B 4F 53 00 00 00																														
5	UP ARROW	ESC [B	1B 5B 42 00 00 00																														
6	DOWN ARROW	ESC [A	1B 5B 41 00 00 00																														
7	ENTER	CR	0D																														
Power-up / Reset	No power up / reset response is sent when the display is configured for ANSI protocol.																																